

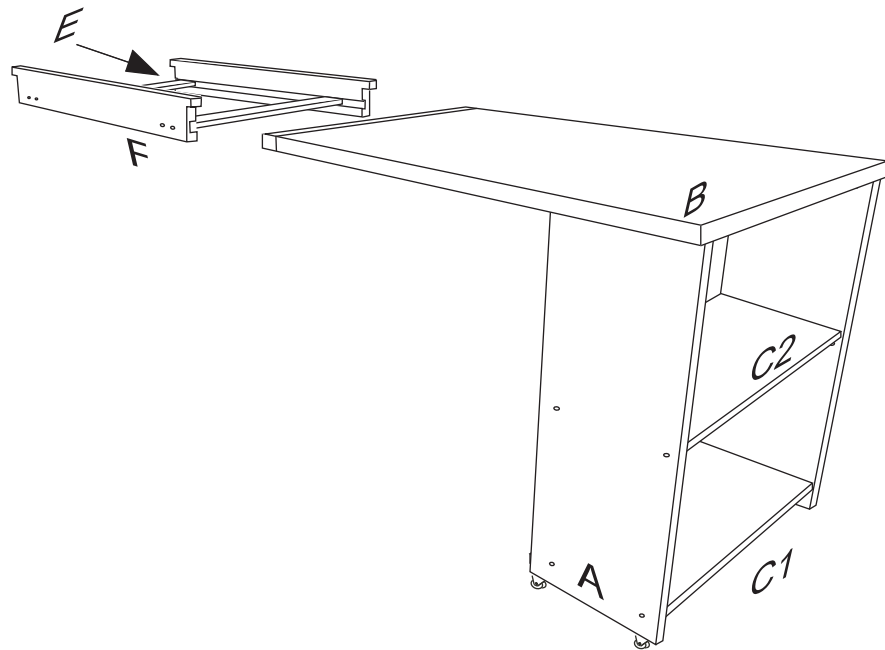







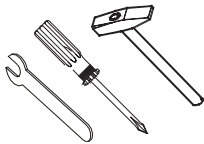

# DOMINO

č. D 707

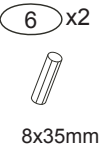

 Kolíky vždy narazte nejprve do otvorů ve hranách dílců, je nutné je zarazit se stejným přesahem. V případě, že některý kolík přesahuje, je nutné jej zakrátit. Dílce srážejte kladivem pouze přes dřevěnou podložku.

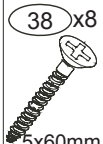
V případě vrzání vtačte do spoje tekuté mýdlo v poměru 1:1 s vodou. Tento jev se u nábytku z masivu vyskytuje běžně.

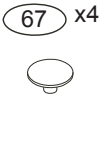
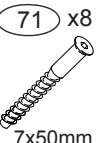
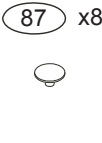
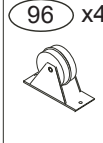
	 4 x1 č.4	 6 x2 8x35mm	 21 x8 3x20mm	 23 x3 4x30mm	 29 x4 4x40mm	 38 x8 5x60mm
	 60 x4 15mm	 61 x4 DU 2	 67 x4	 71 x8 7x50mm	 87 x8	 96 x4

