

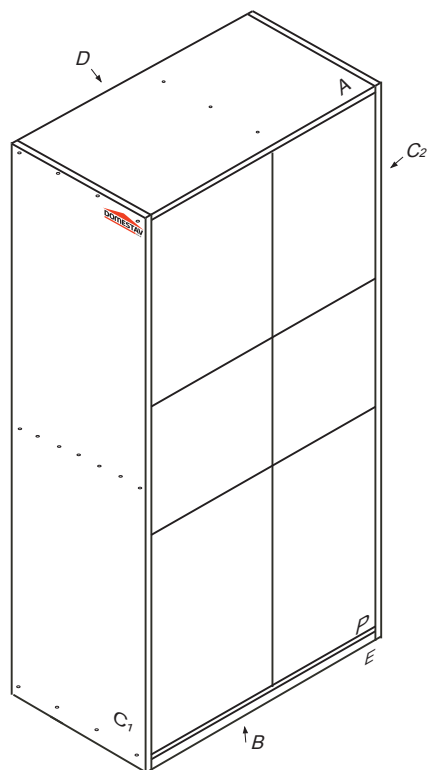

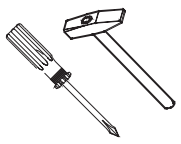

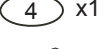







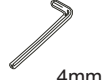

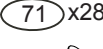

DOMINO 1200

D650/L, D650/LBC, D650/LD

1/2



	 4 x1	 6 x48	 23 x8	 24 x12	 28 x4
	 4mm	 8x35mm	 3,5x16mm	 4x16mm	 4x35mm
	 71 x28	 87 x22	 88 x6 kluzák plastový	 89 x4	 92 x70
	 7x50mm			 1,4x20mm	

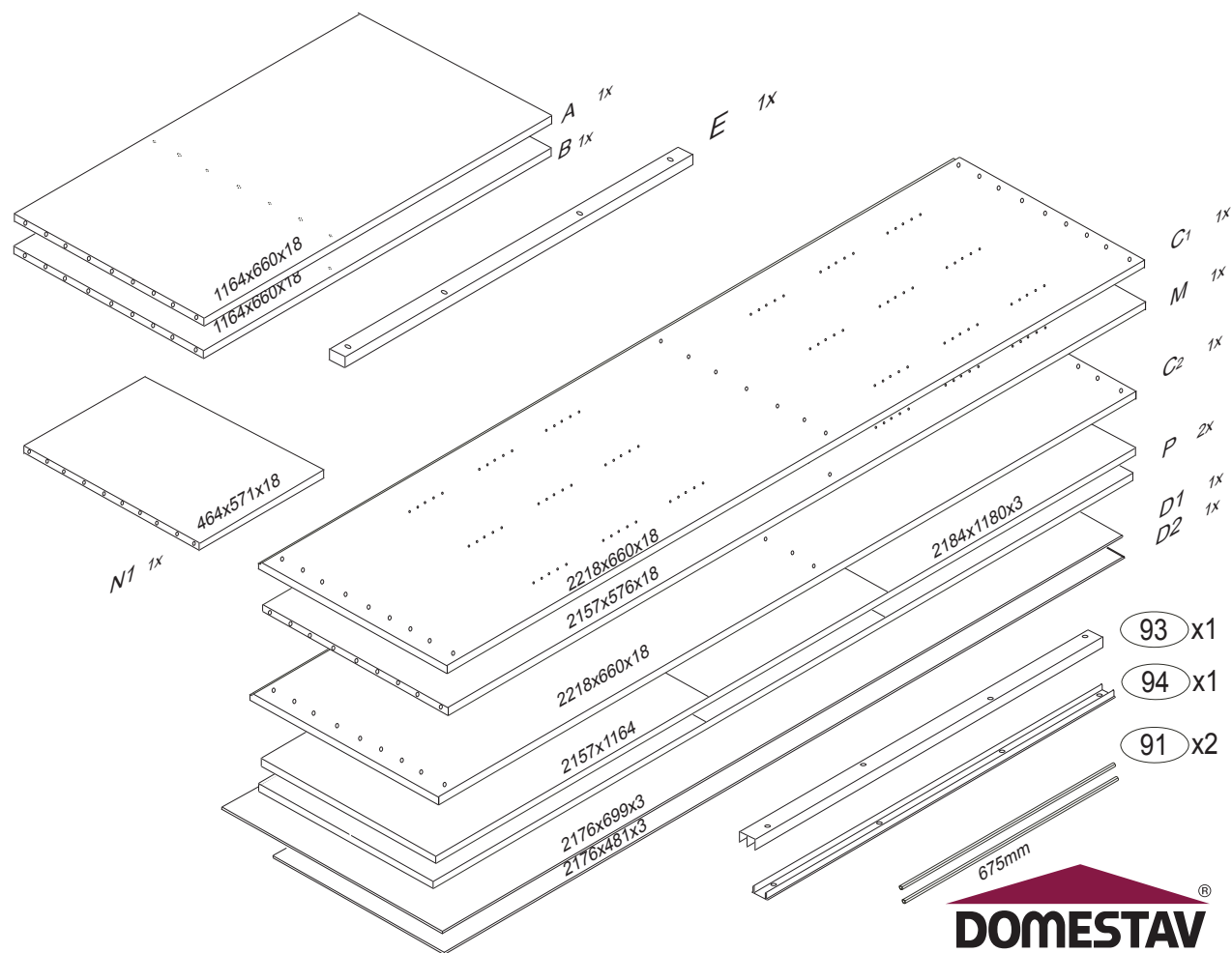

Kolíky vždy narazte nejprve do otvorů ve hranách dílců, je nutné je zarazit se stejným přesahem. V případě, že některý kolík přesahuje, je nutné jej zakrátit. Dílce srážejte kladivem pouze přes dřevěnou podložku.

D 650
D 661
650

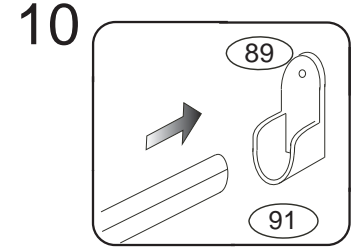
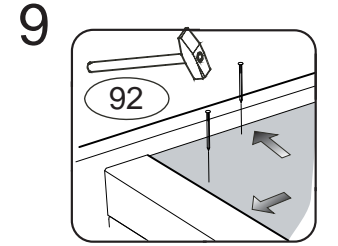
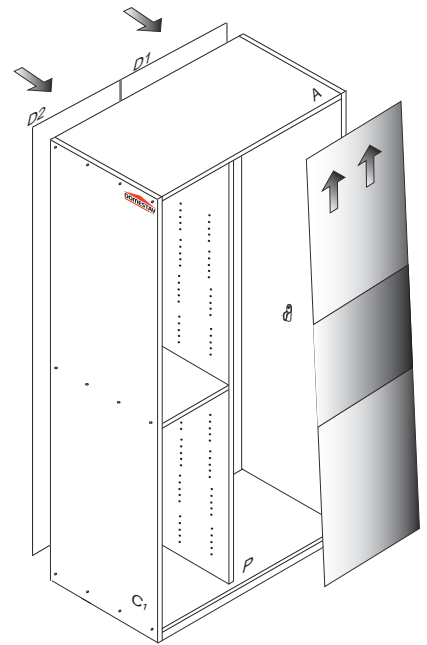
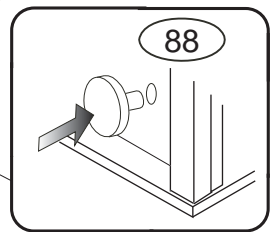
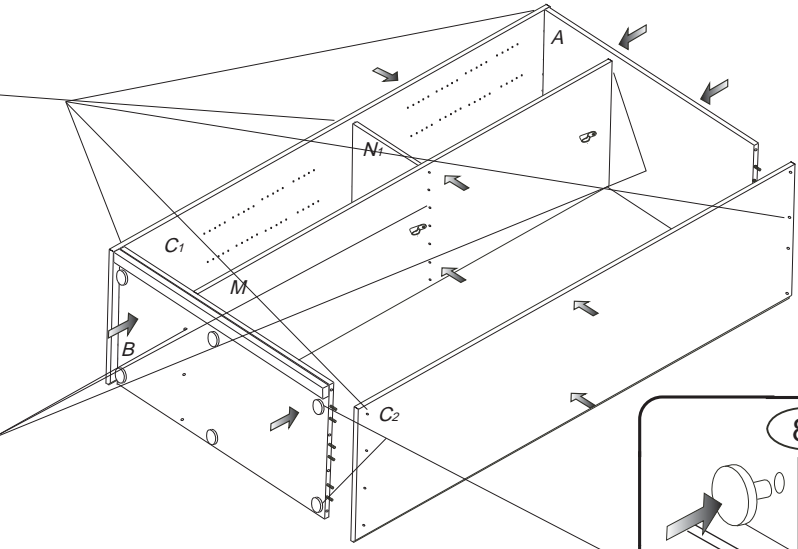
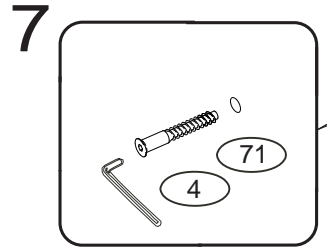
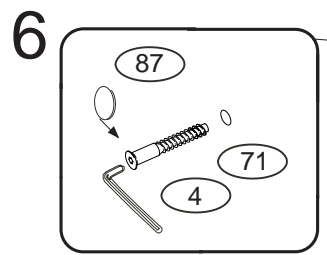
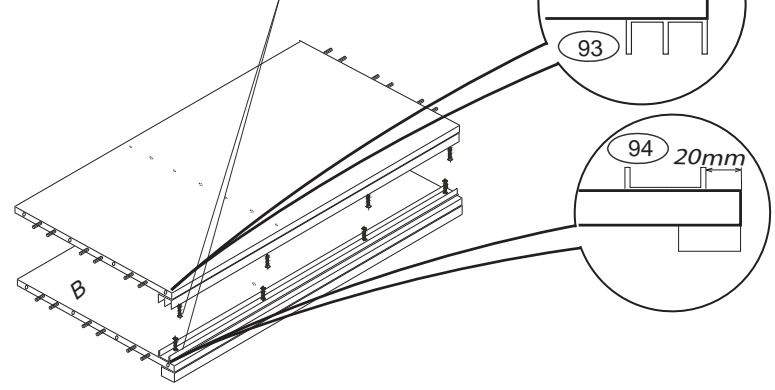
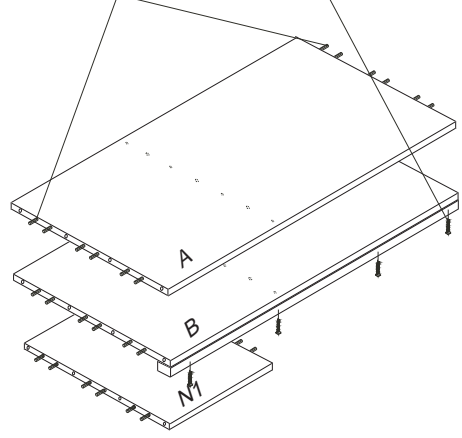
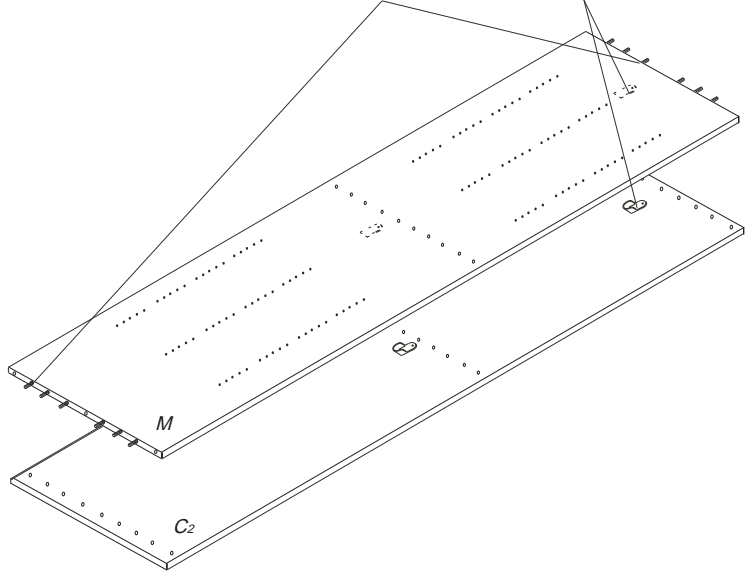
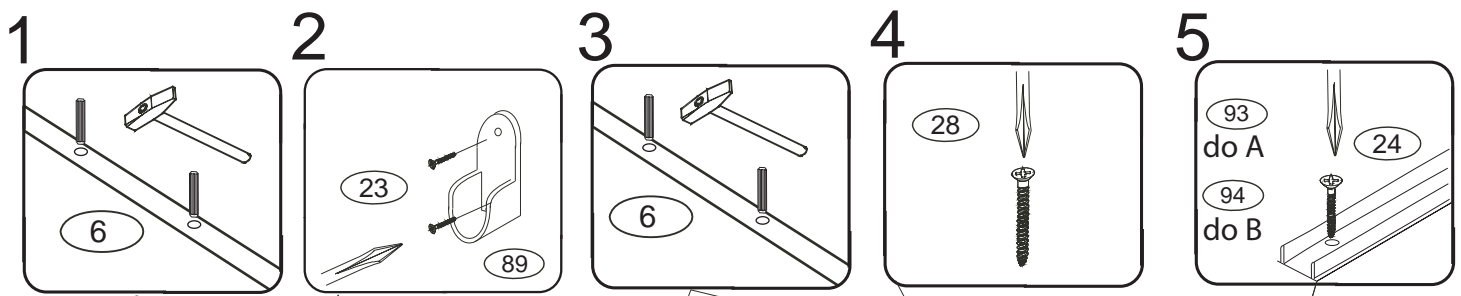

11 Dveře nasadte nejprve do horní lišty, potom do spodní lišty.